

Agilent Metrology of Advanced Optical Modulation Formats

White Paper

by Bernd Nebendahl, Bogdan Szafraniec¹

Agilent Technologies, Digital & Photonic Test, Herrenberger Str. 130, 71034 Böblingen, Germany

¹ Agilent Laboratories, 5301 Stevens Creek Blvd., MS 54U-SC, Santa Clara, CA 95051, USA

Abstract

The metrology basics for advanced optical modulation formats are presented. The methods based on a delay line interferometer, a coherent receiver with frequency domain detection, and a coherent receiver with time domain detection are presented and compared, considering the strengths and limitations of each method.

Introduction

The fundamental methods of encoding digital information onto an optical carrier are identical to the methods that have been developed and are widely used in the RF and wireless world. The only difference between the optical and the radio transmission is the frequency of the carrier. In the case of radio transmission, the carrier frequency can be as low as a few kHz (long wave radio) and as high as a few GHz (analog or digital satellite communications or TV broadcast). For optical long haul communication, carrier frequencies are higher by many orders of magnitude and reside around 200 THz. In both cases, the channel bandwidth is just a small fraction of the carrier frequency; however, that small fraction at the optical frequencies can reach bandwidth of tens of GHz.



Agilent Technologies

While in RF and wireless transmission, so-called advanced modulation schemes of digital transmission are widely used, in optics the vast majority of digital information is transmitted using the simplest digital modulation format: on-off-keying (OOK). While being simple to generate and to detect, OOK suffers from various problems, especially from its poor spectral efficiency. The OOK signals occupy large bandwidth, which results in low tolerance to chromatic and polarization mode dispersion and limits the number of available channels.

Similarities of Advanced Modulation Formats

The terms “advanced modulation formats” or “complex modulation formats” are not precisely defined in the fiberoptic community, but typically almost everything beyond OOK is called “advanced”. Most, if not all, modulation formats that are currently being investigated under the name “advanced” have one thing in common; the information is no longer encoded onto just the amplitude (or power) of the optical carrier, but also onto the phase and often onto the polarization state. There is a vast number of different modulation schemes spanning from very simple phase modulation like binary phase shift keying (BPSK), where there are only two symbols, to quadrature amplitude modulation (QAM,) where the number of symbols can be as high as 1024 for QAM 1024.

One should note that an optical wave, just like any electromagnetic wave, can be decomposed into two orthogonal polarization states. In consequence, it is possible to encode information onto the two orthogonal polarization components independently. This technique is often called polarization multiplexing. The practice of using polarization state is not common in wireless communication with exception for some special cases.

Implications on Test and Measurement Instrumentation

For the OOK modulation format, it is sufficient to detect the power of the optical carrier (direct detection) to recover the digital information. This can be accomplished by using a photodiode that converts optical power into electrical current. If the optical carrier is described by a complex variable S , the current I_{photo} that is produced in the photo diode is proportional to the product of the signal S and its complex conjugate S^* . Thus, for the optical carrier $S = A_s \exp(j\Phi_s + j\omega_s t)$, where ω_s represents the angular frequency, Φ_s the phase, and A_s the amplitude, the photo current can be described by the following equation:

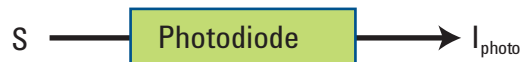

Figure 1.

$$I_{\text{photo}} \propto S \cdot S^* = \underbrace{(A_s e^{j\Phi_s} e^{j\omega_s t})}_S \cdot \underbrace{(A_s e^{-j\Phi_s} e^{-j\omega_s t})}_{S^*} = A_s^2 \quad (1)$$

As indicated by Eq. (1), the direct detection results in loss of phase information. Thus, the advanced modulation formats that contain phase information require a detection technique that provides a measurement of phase ϕ_s . Furthermore, in the case of polarization-multiplexed signals, the phase must be measured for two orthogonal polarization states (polarization resolved measurement). Since the rapidly changing phase of an optical carrier is not directly measurable, the technique must rely on a relative measurement with respect to some phase reference. Once a phase reference is available, it is possible to convert the phase difference between the signal and the phase reference into power and then, by using conventional detection methods, to convert power into an electrical current. Let us look at the superposition of an optical signal S and a phase-reference optical signal R . Since each of the signals is complex, we follow the procedure outlined above:

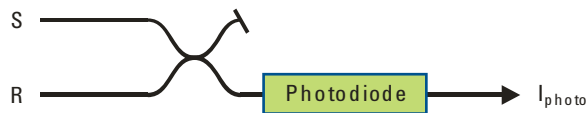

Figure 2.

$$\begin{aligned}
 I_{\text{photo}} &\propto (S + R) \cdot (S + R)^* = \left(\underbrace{A_S e^{i\phi_S} e^{i\omega_S t}}_S + \underbrace{A_R e^{i\phi_R} e^{i\omega_R t}}_R \right) \cdot (\dots)^* \\
 &= A_S^2 + A_R^2 + 2 \cdot A_S \cdot A_R \cdot \cos(\Delta\phi + \Delta\omega \cdot t)
 \end{aligned} \tag{2}$$

As shown in Eq. (2), the result still has time independent terms that represent the power of the signals S and the phase reference signal R , but in addition there is a new term that depends on the phase difference $\Delta\phi$. Usually, the phase (frequency) difference term is called the beat term or the heterodyne term. The beat term results from the “beating” (mixing) of the optical signals at the square-law detector. One should note here that the photocurrent might now change due to changes of the amplitude and/or phase of either of the signals, S or R . This will have some implications in the practical realizations of the phase measurement techniques in the presence of amplitude modulation.

All methods discussed below use the principle of comparing the phase of the received signal S to the phase of a reference signal R . This is accomplished by superimposing two optical signals in an optical combiner, and then detecting the combined optical signals using a square-law detector (photo diode) that produces the beat tone.

Phase Reference Sources

There are two basic ways to obtain the reference for a phase measurement. Either one can use the signal itself to generate a phase reference or one can use an independent source as a phase reference signal. One might ask how the signal itself can become a reference. What makes it possible is the fact that we

are usually interested in the phase changes over time. It is therefore possible to split the optical signal and use a delayed portion of the signal as a phase reference in a so-called delay line interferometer.

The alternative method uses another laser source that acts as a local oscillator (LO) within the coherent receiver. The LO serves as a phase reference signal. From a mathematical point of view it does not matter, whether the local oscillator is external or produced from the modulated signal itself. Furthermore, it is not critical, whether the external LO is free running or somehow locked to the transmitter carrier. In all cases, we are dealing with a coherent receiver. From a qualitative point of view, using an LO offers a better signal-to-noise than self-beating.

Balanced Receivers

There is yet another concept to introduce before different realizations of the phase measurements are analyzed. We have seen that the direct detection of the superposition of the modulated signal and the reference signal contains terms that do not depend on the phase difference. In fact, the terms represent the power of the signal and the reference. There is however a very simple method of suppressing the power terms by utilizing a balanced receiver, as shown in Fig. 3. A crucial function implemented within the balanced receiver is combining two optical waves. This can be accomplished by using a partially reflecting mirror or a fiber optic coupler; the results are equivalent.

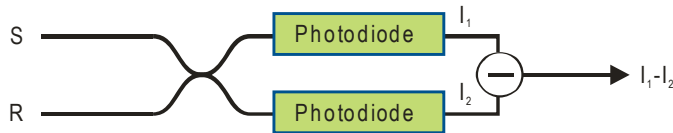

Figure 3.

Figure 3 shows a realization using a fiber optic 2x2 coupler/combiner. In the previous chapter, we have looked at only one output of the combiner. If both outputs are considered and the difference between the intensities is calculated, the following result is obtained:

$$\begin{aligned}
 I_1 - I_2 &\propto \underbrace{\left((S+R) \cdot (S+R)^* \right)}_{I_1} - \underbrace{\left((S-R) \cdot (S-R)^* \right)}_{I_2} \\
 &= 4 \cdot A_S \cdot A_R \cdot \cos(\Delta\phi + \Delta\omega \cdot t)
 \end{aligned}
 \tag{3}$$

Obviously, subtracting the photo currents of photo diode one and two preserves the beat term while the power terms cancel out. The subtraction of power is easy to understand; the power signals at both outputs are identical. The fact that the subtraction results in a doubly strong beat signal is the consequence of a general property of the coupler that creates different phase shifts for optical waves exiting its two output arms. In the case of a 2 x 2 coupler the relative

phase difference between S and R at both outputs is equal to π . Thus, after subtraction, the beat term doubles. We now have the necessary background to examine in details three basic test methods, two of them utilizing a coherent receiver and one utilizing a delay line interferometer.

Delay Line Interferometer

Theory of operation

The delay line interferometer utilizes a delayed copy of the signal to create the phase reference (Figure 4).

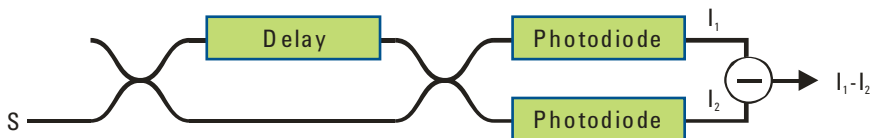

Figure 4.

Now, $I_1 - I_2$ is given by:

$$\begin{aligned}
 I_1 - I_2 &\propto \underbrace{\left((S(t) + S(t+T)) \cdot (\dots)^* \right)}_{I_1} - \underbrace{\left((S(t) - S(t+T)) \cdot (\dots)^* \right)}_{I_2} \\
 &= 4 \cdot A_S(t) \cdot A_S(t+T) \cdot \cos(\phi(t) - \phi(t+T))
 \end{aligned} \tag{4}$$

For simplicity, we omitted any frequency or phase noise of the carrier. In practice this will result in some additional amplitude noise of the signal. As shown in Eq. (4), the difference in intensities $I_1 - I_2$ now depends on the cosine of the phase difference between the original signal and its delayed copy; the delay corresponds to the time delay of the interferometer. Due to the periodicity of the cosine function only phase differences between 0 and π can be uniquely identified but only if delay T is an integer multiple of the carrier period $2\pi/\omega_s$. While this result is sufficient for modulation formats like BPSK, it does not work for formats like quadrature phase shift keying (QPSK) or n-level phase shift keying n-PSK. In those cases, an additional delay line interferometer having phase shift of $\pi/2$ is also required. This allows creation of the quadrature signal and full 2π phase coverage, as explained below.

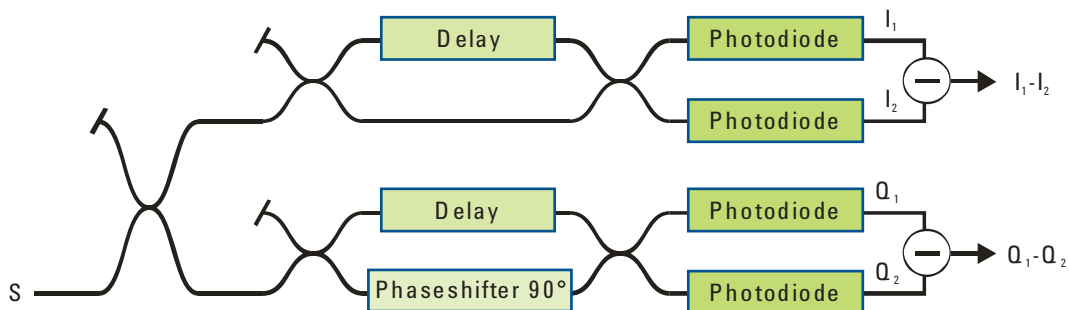

Figure 5

The improved arrangement is shown in Figure 5. While $I_1 - I_2$ stays the same the new term $Q_1 - Q_2$ is given by

$$Q_1 - Q_2 \propto \underbrace{\left((S(t) + i \cdot S(t+T)) \cdot (\dots)^* \right)}_{a_1} - \underbrace{\left((S(t) - i \cdot S(t+T)) \cdot (\dots)^* \right)}_{a_2} \quad (5)$$

$$= 4 \cdot A_S(t) \cdot A_S(t+T) \cdot \sin(\phi(t) - \phi(t+T))$$

This new term depends on the sine of the phase difference. Thus, utilizing both terms together, one is able to measure the phase difference over the whole range from 0 to 2π . Now it is also possible to distinguish phase information from amplitude information using the simple formulae shown below:

$$A_S(t)A_S(t+T) \propto \sqrt{(I_1 - I_2)^2 + (Q_1 - Q_2)^2} \quad (6)$$

$$\phi(t) - \phi(t+T) = \arctan((I_1 - I_2), (Q_1 - Q_2))$$

The above formulae show a unique determination of the phase difference, however, the amplitude of the modulated signal is only the geometric mean of the amplitudes of the signal and its delayed copy. Figure 6 shows the complete delay interferometer based system that will be required to analyze polarization multiplexed signals.

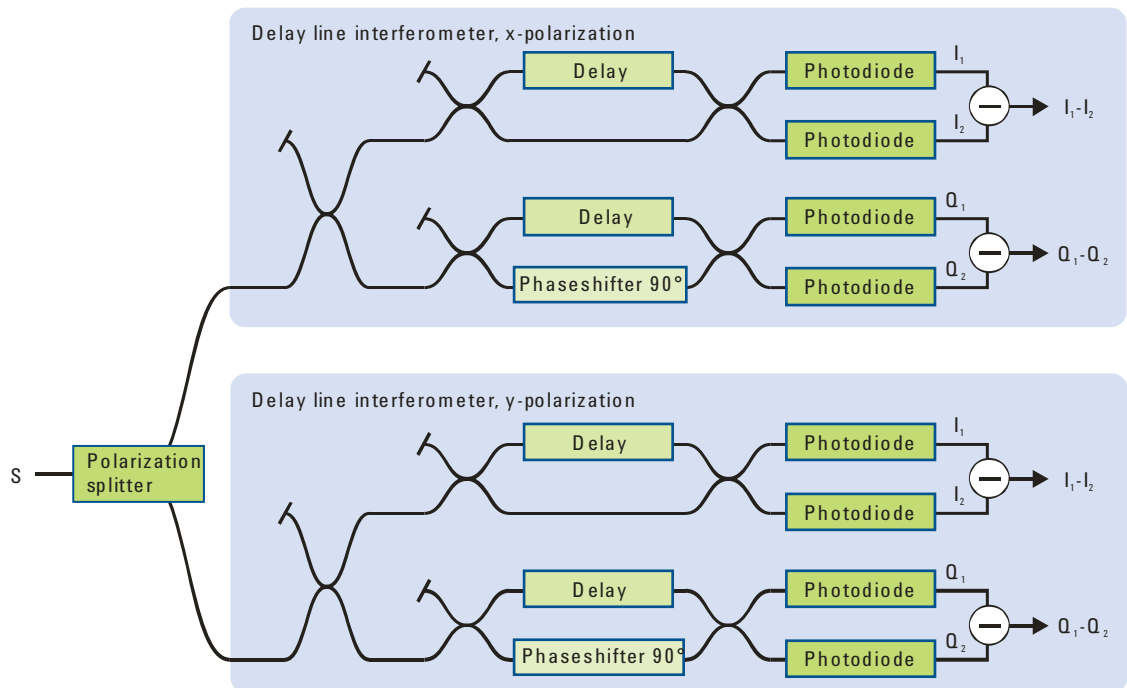

Figure 6.

Limitations of the Delay Line Interferometer

In order to measure changes of the phase and amplitude of the signal over time, a delay and sampling period much smaller than the symbol period has to be used. With the high symbol rates considered today, this offers a considerable challenge compared to the other methods discussed in this paper. Of course, the delay can be increased and as a consequence the sampling period reduced to the symbol period for modulation formats that do not encode information in the amplitude, but then the usable symbol periods are also limited to values approximately equal to the delay. This can also be overcome by using tunable delay lines, but the required precise control and high stability offer an additional challenge. In addition, since the phase reference was created from the signal itself, whose power might be low, the detection sensitivity is lower than in a coherent receiver with a high power phase reference. If one chooses to implement the method with a sampling technique, the measurement time will increase and a trigger will be required either directly from the transmitter or through a clock recovery circuit.

Benefits of the Delay Line Interferometer

Of course, there are certain benefits that a delay line interferometer offers. The method is self-referenced; it always creates the beat signal. It does not require a local oscillator; therefore, it avoids the complications associated with local oscillator control and with the phase noise introduced by the local oscillator. For a signal in a single polarization state, the method is therefore easy to implement. If a symbol or pattern trigger is available, the detection can be implemented using time domain-sampling techniques, which offer higher bandwidth compared to real time sampling but of course at the price of longer measurement time.

Frequency Domain Detection

Theory of Operation

In order to reconstruct a time domain signal from the frequency domain it is necessary to measure the complex spectrum, i.e., amplitude and phase information are required. A spectrum analyzer that is capable of measuring not only the amplitude but also the phase is often referred to as a complex spectrum analyzer.

A spectrum analyzer can be realized using a dispersive element that separates different optical frequencies and allows simultaneous detection of multiple frequency bands by multiple detectors. Alternatively, a spectrum analyzer can use a scanning narrow band optical filter and a single detector so that different frequency bands are detected sequentially. The frequency resolution required to analyze the modulated optical signals is currently only achievable by realizing the narrow band filter with a narrow-line width tunable laser, either in a traditional coherent detection system or using non-linear optical effects.

In order to illustrate the complex spectrum approach, we assume that the spectrum can be described by a sum of multiple peaks that have a certain amplitude and phase. The frequency spacing is assumed to be proportional to $1/T$, where T is the symbol period:

$$S = \sum_n A_n e^{i\phi_n} e^{i\left(\omega_s + n \frac{2\pi}{T}\right)t} \quad (7)$$

To measure the individual amplitude A_n the signal is combined with a (tunable) LO with only a single line:

$$R = e^{i(\omega_R - \Delta\omega)t} \quad (8)$$

The intensity of the combined signal is

$$\begin{aligned} I_{\text{photo}} &\propto (S + R) \cdot (S + R)^* \\ &= \left(\sum_n A_n e^{i\phi_n} e^{i\left(\omega_s + n \frac{2\pi}{T}\right)t} + e^{i(\omega_R - \Delta\omega)t} \right) \cdot (\dots + \dots)^* \\ &= 1 + \sum_n \sum_k A_n \cdot A_k \cdot \cos(\phi_n - \phi_k + (n - k) \frac{2\pi}{T} t) + \\ &\quad \sum_n 2A_n \cos(\phi_n + (\omega_s - \omega_R + \Delta\omega + n \frac{2\pi}{T}) \cdot t) \end{aligned} \quad (9)$$

If $\omega_s - \omega_R + n (2\pi/T) = 0$ narrowband detection at $\Delta\omega$ recovers the individual amplitudes A_n . The phase ϕ_n however cannot be measured with this approach.

To measure the phase an LO with two lines is used:

$$R = e^{i\omega_R t} + e^{i\left(\omega_R - \Delta\omega + \frac{2\pi}{T}\right)t} \quad (10)$$

Based on Equation 7 and Equation 10, the intensity of the combined signal is:

$$\begin{aligned} I_{\text{photo}} &\propto \left(\sum_n A_n e^{i\phi_n} e^{i\left(\omega_s + n \frac{2\pi}{T}\right)t} + e^{i\omega_R t} + e^{i\left(\omega_R - \Delta\omega + \frac{2\pi}{T}\right)t} \right) \cdot (\dots + \dots)^* \\ &= 2 + \sum_n \sum_k A_n \cdot A_k \cdot \cos(\phi_n - \phi_k + (n - k) \frac{2\pi}{T} t) + \\ &\quad \sum_n 2A_n \cos(\phi_n + (\omega_s - \omega_R + n \frac{2\pi}{T})t) + \\ &\quad \sum_n 2A_{n+1} \cos(\phi_{n+1} + (\omega_s - \omega_R + \Delta\omega + n \frac{2\pi}{T})t) \end{aligned} \quad (11)$$

If $\omega_s - \omega_r + n (2\pi/T) \approx 0$ narrowband detection recovers only the following term,

$$\sum_n 2[A_n \cos(\phi_n + (\omega_s - \omega_r + n \frac{2\pi}{T})t)] + \sum_n 2[A_{n+1} \cos(\phi_{n+1} + (\omega_s - \omega_r + \Delta\omega + n \frac{2\pi}{T})t)] \quad (12)$$

with $\Delta\phi_n = \phi_n - \phi_{n+1}$. From these phase differences between neighboring sidebands it is possible to calculate back to the actual phase and from that together with the amplitudes, the time domain signal is reconstructed for further processing. Figure 7 shows the complete setup used to measure a polarization resolved complex spectrum.

$$8A_n A_{n+1} \cos(\Delta\phi + \Delta\omega t) \quad (13)$$

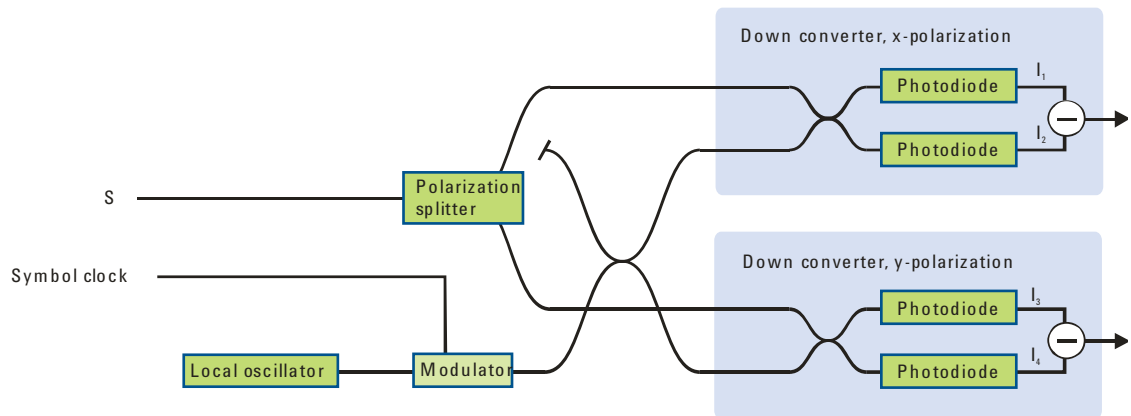

Figure 7

Limitations of Frequency Detection

The complex spectrum method has some fundamental limitations. As shown above, the method only works for periodic signals that result in discrete spectral peaks. At the same time, the symbol clock is required for the method. The precision of reconstruction of the time domain depends on the quality of the spectral measurement. In particular, the accuracy of the method depends directly on the spectral resolution since this sets the ultimate limit for the spacing of sidebands that can be resolved. For coherent detection, the spectral resolution roughly equals to the line width of the phase reference signal (LO). However, if the line width of the carrier of the optical modulated signal is larger the line width of the LO, the carrier line width has to be taken into account. Thus, there always is a lower limit for the resolvable sideband spacing. Since the width of the spectrum of the modulated signal depends on the symbol rate, the spectral resolution sets an upper limit for the number of detectable sidebands within a complex spectrum. For example, if the line width is approximately 5 MHz (DFB laser) and the symbol rate is 20 GBaud, the theoretical limit for the number of resolvable sidebands is around 4000. This however is a theoretical number

that has not been reached in practical implementations as of today. The actual numbers of resolvable sidebands is more in the order of a few tens. Since the number of sidebands is directly related to the length of the periodically repeated bit pattern, the pattern length is also limited to a few tens of symbols. Since the method requires sweeping the local oscillator and requires narrowband detection of the signals it will require a longer measurement time compared to time domain methods and in particular for real time measurements. In addition, it will in principle average out any effects that are not periodic in particular this is true for any polarization mode dispersion present on the transmission link that cannot be compensated.

Benefits of frequency domain detection

The biggest benefit of the frequency domain detection, as compared with other methods, is almost unlimited bandwidth (unlimited time resolution). The sweep range of the local oscillator determines the bandwidth. This results in a bandwidth of up to a few tens of THz with today's tunable external cavity lasers. In addition, since all processed signals are narrow band, the system can be implemented without high-speed data acquisition and high-speed receiver.

Coherent Receiver and Time Domain Detection

Theory of operation

As shown in the section on delay line interferometers, a very important step in measuring the phase of the optical signals is creating the quadrature signal. By having the in-phase (I) and quadrature (Q) components of the signal, it is very straightforward to create the analytical signal $z = I + jQ$.

The complex analytical signal gives easy access to phase and amplitude:

$$\begin{aligned} A &= |z| = \sqrt{I^2 + Q^2} \\ \Phi &= \arg(z) = \arctan(I, Q) \end{aligned} \tag{14}$$

Furthermore, by taking the Fourier transform of the analytical signal, the complex spectrum can be easily reconstructed. Thus, receivers that provide quadrature output allow full signal reconstruction in both time and frequency domain.

The coherent receiver that provides the in-phase and quadrature outputs is often used at RF frequencies. Its implementation at optical frequencies requires the ability to shift the LO phase by $\pi/2$ when creating a quadrature signal. This takes place in an optical component known as IQ-demodulator. For polarization multiplexed signals, the receiver must be implemented for two orthogonal polarization states. The separation of the two orthogonal polarizations is accomplished by a polarization splitter that is placed at the input of the receiver as shown in Figure 8.

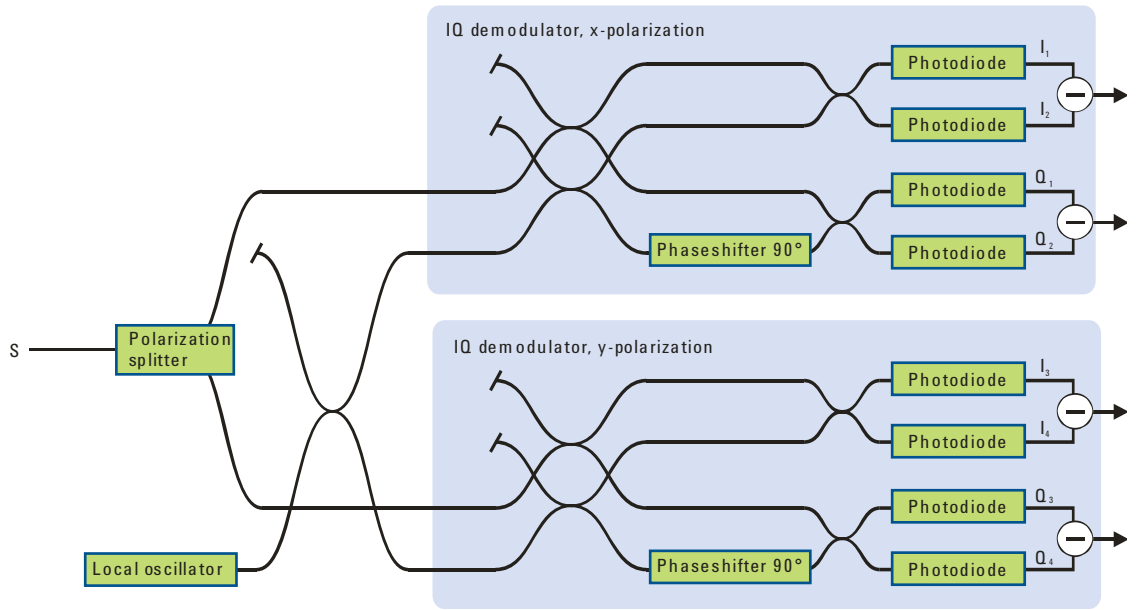

Figure 8.

To analyze the operation of the optical coherent receiver we start with Eq. (3) that shows the in-phase component after balanced receiver subtraction. The in-phase beat term of Eq. (3) gives the phase of the signal S relative to the local oscillator phase. As shown in Fig. 8, the second combiner is required to create the quadrature signal. The quadrature signal is constructed by shifting the LO phase by $\pi/2$. The optical circuit is duplicated for both orthogonal polarization states to resolve polarization-multiplexed signals. The four outputs of the receiver are described by the following set of equations:

$$\begin{aligned}
 I_1 - I_2 &\propto 4 \cdot A_S^h \cdot A_R \cdot \cos(\Delta\phi - \Delta\omega \cdot t) \\
 Q_1 - Q_2 &\propto 4 \cdot A_S^h \cdot A_R \cdot \sin(\Delta\phi - \Delta\omega \cdot t) \\
 I_3 - I_4 &\propto 4 \cdot A_S^v \cdot A_R \cdot \cos(\Delta\phi - \Delta\omega \cdot t) \\
 Q_3 - Q_4 &\propto 4 \cdot A_S^v \cdot A_R \cdot \sin(\Delta\phi - \Delta\omega \cdot t)
 \end{aligned} \tag{15}$$

In the above equations, the upper indices h and v denote the horizontal and vertical polarization states of the optical signal with respect to the [polarization] reference frame of the receiver. All the detected signals oscillate at the angular frequency that originates from the frequency offset between the carrier and the local oscillator. This frequency offset would be zero if the local oscillator were optically phase locked to the carrier. However, locking the LO to the carrier is quite difficult because many of the advanced modulation formats do not contain a strong carrier. It turns out that it is easier to solve this problem differently. The analytical signal z , as shown in the complex plane, creates an image that is known as a constellation diagram. Typically, the constellation diagram is used to show the locations of the detected symbols and the trajectory that connects

them and illustrates transitions between the symbols. An offset between the LO and the carrier creates a rotation vs. time of the constellation at the rate ω_{offset} . Since today's transmitter lasers and the local oscillator lasers offer enough stability and frequency accuracy to keep the offset within some hundreds of MHz, the rotation of the constellation is relatively slow compared to the typical symbol rates, that are as high as a few GBaud. Therefore, by observing the constellation and its behavior, it is possible to distinguish between the symbols and their slow rotation. This leads to the recovery of the frequency offset, or in other words the carrier, by signal post-processing. The tolerance of the post processing algorithms depends on the modulation format, however, one can estimate the upper limit of the frequency offset that an algorithm can compensate. In order to do that, one needs to consider the smallest angular distance between the symbols of the constellation. For example, the smallest angular distance for QPSK constellation is $\phi_{\text{min}} = \pi/2$. Thus, the rotation of the constellation within the time equal to one symbol period needs to be smaller than half $\phi_{\text{min}} = \pi/2$. Mathematically, the maximum frequency offset is given by

$$\nu_{\text{offset}} = \frac{\phi_{\text{min}}}{4\pi} \cdot \nu_{\text{Symbol}} \quad (16)$$

In the above example of QPSK modulation, for a symbol rate of 10 GBaud, the maximum frequency offset between the LO and the carrier is about 1.2 GHz. This corresponds to 12% of the symbol rate. In practice, depending on the algorithm used, the tolerance to offset is slightly smaller and equal to about 10% of the baud rate. However, the tolerable offset is well within the carrier stability specification of a typical transmitter or a typical laser used as the LO. For BPSK modulation, the tolerance is twice larger and equal to about 20% of the baud rate.

As already mentioned, the receiver illustrated in Fig. 8 allows the detection of polarization-multiplexed signals without a need for optical polarization control. This is because the electrical signals produced by a receiver represent a frequency-shifted copy of the optical signal that arrives at the receiver. Hence, the electrical signals are a measure of the electrical field of the optical wave. This direct access to the field allows mathematically compensating for polarization misalignment and for polarization mode dispersion. Furthermore, any linear distortion like the chromatic dispersion of the transmission link can also be compensated.

Limitations of Time Domain Detection

We have seen that the limitations described for the delay line interferometer method and complex spectrum method do not apply to the time based coherent detection. However, the bandwidth of today's real time sampling oscilloscopes limits the achievable bandwidth of this method. Having the in-phase and quadrature signals effectively doubles the optically usable bandwidth as compared to the available electrical bandwidth of the oscilloscope. Nevertheless, today's real time sampling oscilloscopes do not fully cover the complete channel bandwidth of the 50 GHz ITU-T grid. A bandwidth of 25 GHz and sampling rate of 50 GS/s on all four channels are required to cover the whole channel bandwidth of 50

GHz. The good news is that the oscilloscopes offering this type of bandwidth and sampling rates are already visible on the horizon.

Benefits of Time Domain detection

We have already touched upon many of the advantages of the time-based coherent detection. In contrast to the frequency-based method, this method has no limitations with respect to pattern length; it even works for real data streams. Remarkably, since the method measures the electrical field of the optical wave rather than its power, it is possible to correct for linear distortions like chromatic dispersion or polarization mode dispersion. Furthermore, it is possible to process polarization multiplexed signals by means of mathematical transformation, independent of the modulation format. The time-based coherent detection method is suitable for all modulation formats including orthogonal frequency domain multiplexing (OFDM). The feature of greatest importance in practical measurements is that the method does not require a symbol clock since the clock recovery occurs in software processing.

Finally, it is important to emphasize that the most promising implementation of receivers in the optical networks use the method of coherent detection in connection with real time processing. Thus, use of the same design principle in the test equipment ensures the minimal discrepancies between the test and real life applications.

Real Time vs. Repetitive Sampling

Periodic waveforms can be reconstructed by sampling them at slow rates over many periods. This type of sampling is often referred to as repetitive sampling. The strength of the repetitive sampling method is its ability to reconstruct high frequency waveforms using low frequency sampling. The penalty is the increase of the measurement time, that is especially severe for long digital sequences (the same sequence has to be measured many times). In the real time sampling method, the samples are acquired at rates that are higher than the frequencies of measured waveforms, in accord with the Nyquist theorem. The real time sampling approach does not have a constraint of the waveform being periodic.

The bandwidth of real time oscilloscopes is traditionally lower than the bandwidth of repetitive-sampling oscilloscopes. For example, optical sampling oscilloscopes offer bandwidth that is defined by a sub-picosecond duration of the optical pulse that samples the optical waveform. This offers phenomenally large bandwidth. However, the rate of sampling corresponds to the repetition rate of the optical pulses, typically tens of MHz. We have seen that the bandwidth of today's real time oscilloscopes does not allow covering a full 50 GHz ITU channel. Thus, the question arises: what prevents the use of the repetitive sampling techniques in optical coherent detection? The difficulty is related to the time-varying frequency offset between the optical carrier of the modulated signal and the local oscillator. This frequency offset must be corrected either through data processing or by locking the LO to the optical carrier of the modulated optical signal using an optical phase-locked loop. As already mentioned, locking the

LO to a modulated optical signal is difficult. Therefore, a preferred solution is a signal processing approach that removes the frequency offset after digitization. In the case of the real time sampling as discussed above, the frequency offset has to be within about 10% of the symbol rate for a QPSK format. However, if one were to apply a similar principle to the case of repetitive sampling, the symbol rate would have to be replaced by the rate at which the individual symbols are reconstructed. However, the reconstruction rate depends on the length of the sequence. In the case of long sequences, the reconstruction of a single symbol takes many sequence periods. Thus, the measurement time of a single symbol using repetitive sampling may be many orders of magnitude longer than the measurement time in the method of real time sampling. Consequently, the tolerable rotation of the constellation (the tolerable frequency offset) becomes many orders of magnitude smaller, excluding the possibility of using an unlocked LO. This limits the use of the repetitive sampling techniques to very short sequences that can be reconstructed within a time comparable to that of the real time sampling method.

Conclusion

We have reviewed the metrology basics of advanced modulation formats. The three most frequently used measurement methods, based on delay line interferometers, complex spectrometers, and real time coherent detection were analyzed and compared. Each method was shown to have certain limitations and benefits. We believe that the real time coherent detection method provides the best fit to the measurement needs of optical communications. We expect that the currently available bandwidth of the real time oscilloscopes will increase in the near future, enabling the real time sampling method for analysis of 100Gb/s optical links. The extremely high bandwidth of the complex spectrum and optical sampling methods will certainly find interesting application. However, due to the trade-offs that are required to achieve such a high bandwidth it may not be best suited for analysis of the long haul transmission systems designed for current 50 GHz channels that do not require such high measurement bandwidth. We consider the limitation of the pattern length in the other methods to be very undesirable.



Agilent Email Updates

www.agilent.com/find/emailupdates
Get the latest information on the products and applications you select.

Remove all doubt

Our repair and calibration services will get your equipment back to you, performing like new, when promised. You will get full value out of your Agilent equipment throughout its lifetime. Your equipment will be serviced by Agilent-trained technicians using the latest factory calibration procedures, automated repair diagnostics and genuine parts. You will always have the utmost confidence in your measurements. For information regarding self maintenance of this product, please contact your Agilent office.

Agilent offers a wide range of additional expert test and measurement services for your equipment, including initial start-up assistance, onsite education and training, as well as design, system integration, and project management.

For more information on repair and calibration services, go to:

www.agilent.com/find/removealldoubt

Product specifications and descriptions in this document subject to change without notice.

For more information on Agilent Technologies' products, applications or services, please contact your local Agilent office. The complete list is available at:

www.agilent.com/find/contactus

Americas

Canada	(877) 894-4414
Latin America	305 269 7500
United States	(800) 829-4444

Asia Pacific

Australia	1 800 629 485
China	800 810 0189
Hong Kong	800 938 693
India	1 800 112 929
Japan	0120 (421) 345
Korea	080 769 0800
Malaysia	1 800 888 848
Singapore	1 800 375 8100
Taiwan	0800 047 866
Thailand	1 800 226 008

Europe & Middle East

Austria	01 36027 71571
Belgium	32 (0) 2 404 93 40
Denmark	45 70 13 15 15
Finland	358 (0) 10 855 2100
France	0825 010 700*
	*0.125 €/minute
Germany	07031 464 6333**
Ireland	1890 924 204
Israel	972-3-9288-504/544
Italy	39 02 92 60 8484
Netherlands	31 (0) 20 547 2111
Spain	34 (91) 631 3300
Sweden	0200-88 22 55
Switzerland	0800 80 53 53
United Kingdom	44 (0) 118 9276201

Other European Countries:

www.agilent.com/find/contactus

Revised: October 1, 2008

© Agilent Technologies, Inc. 2009
Printed in USA, April 29, 2009
5990-3748EN

